

# **DRAKE**®

**SW2 Shortwave Receiver**  
(with Selectable Sideband Synchronous Detector)

# **Owner's Manual**



Downloaded by   
Amateur Radio Directory   
  
[www.hamdirectory.info](http://www.hamdirectory.info)

# EC-Declaration of Conformity



**We, Manufacturer/Importer**

(Full address)

**R. L. Drake Company  
230 Industrial Drive  
Franklin, Ohio 45005 United States of America**

declare that the product  
(description of the apparatus, system, installation to which it refers)

**SW2 Shortwave Receiver  
1292**

**is in conformity with**

**Council Directive 89/336/EEC (EMC Directive)**

Standards to which conformity is declared:

- |                                  |  |
|----------------------------------|--|
| <b>EN55013</b> :06.90+A12/08.94  | <b>Limits and methods of measurement for radio disturbance characteristics of broadcast receivers and associated equipment.</b>          |
| <b>EN55020</b> :12.94            | <b>Immunity from radio interference of broadcast receivers and associated equipment.</b>   |
| <b>EN55022</b> :08.94+A1:05.95   | <b>Limits and methods of measurement of radio disturbance characteristics of Information Technology Equipment.</b>                       |
| <b>EN50082-1</b> :01.92          | <b>Electromagnetic compatibility - Generic immunity standard.<br/>Part 1: Residential, commercial and light industry.</b>                |
| <b>EN60555-2</b> :04.87          | <b>Disturbances in supply systems caused by household appliances and similar electrical equipment.<br/>Part 2: Harmonics.</b>            |
| <b>EN60555-3</b> :04.87+A1:10.91 | <b>Disturbances in supply systems caused by household appliances and similar electrical equipment.<br/>Part 3: Voltage fluctuations.</b> |

The manufacturer also declares the conformity of above mentioned product with the actual required safety standards in accordance with LVD 73/23 EEC.

**EN 60065** Safety requirements for mains operated electronic and related apparatus for household and similar general use.

**Manufacturer/Importer**

**DRAKE**®

(Stamp)

Signature: Ronald E. Wysong

Date: February 01, 1997

Name: Ronald E. Wysong

WARNING: TO PREVENT FIRE OR ELECTRICAL SHOCK DO NOT EXPOSE THIS PRODUCT'S AC ADAPTOR TO RAIN OR MOISTURE

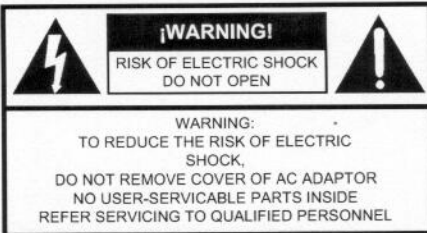

An appliance and cart combination should be moved with care. Quick stops, excessive force and uneven surfaces may cause the appliance and cart combination to overturn.



The lightning flash with arrow head symbol, within an equilateral triangle, is intended to alert the user to the presence of uninsulated "dangerous voltage" within the product's enclosure that may be of sufficient magnitude to constitute a risk of electric shock to persons.



The exclamation point within an equilateral triangle is intended to alert the user to the presence of important operating and maintenance (servicing) instructions in the literature accompanying the appliance.

WARNING: TO REDUCE THE RISK OF FIRE OR ELECTRIC SHOCK, DO NOT EXPOSE THIS PRODUCT'S AC ADAPTOR TO RAIN OR MOISTURE. DO NOT OPEN THE CABINET, REFER SERVICING TO QUALIFIED PERSONNEL ONLY.

CAUTION: TO PREVENT ELECTRIC SHOCK, DO NOT USE THE AC ADAPTOR WITH AN EXTENSION CORD RECEPTACLE OR OTHER OUTLET UNLESS THE BLADES OF THE AC ADAPTOR CAN BE FULLY INSERTED TO PREVENT BLADE EXPOSURE.

ATTENTION: POUR PREVENIR LES CHOCS ELECTRIQUES, NE PAS UTILISER CETTE FICHE POLARISEE AVEC UN PROLONGATEUR, UNE PRISE DE COURANT OU UNE AUTRE SORTIE DE COURANT, SAUF SI LES LAMES PEUVENT ETRE INSEREES A FOND SANS EN LAISSER AUCUNE PARTIE A DECOUVERT.

- 1. Read Instructions**—All the safety and operating instructions should be read before the appliance is operated.
- 2. Retain Instructions**—The safety and operating instructions should be retained for future reference.
- 3. Heed Warnings**—All warnings on the appliance should be adhered to.
- 4. Follow Instructions**—All operating and use instructions should be followed.
- 5. Cleaning**—Unplug this appliance from the wall outlet before cleaning. Do not use liquid cleaners or aerosol cleansers. Use a damp cloth for cleaning.
- 6. Do Not Use Attachments**—not recommended by the manufacturer or they may cause hazards.
- 7. Water and Moisture**—Do not use this product near water—for example, near a bathtub, wash bowl, kitchen sink, laundry tub, in a wet basement, or near a swimming pool—and the like.
- 8. Accessories**—Do not place this product on an unstable cart, stand, tripod, bracket, or table. The product may fall, causing serious injury to a child or adult, and serious damage to the appliance.
- 9. Ventilation**—This product should never be placed near or over a radiator or heat register. This product should not be placed in a built-in installation such as a bookcase or rack unless proper ventilation is provided or the manufacturer's instructions have been adhered to. Any slots or openings in the cabinet are provided for ventilation. To ensure reliable operation of the product and to protect it from overheating, these openings must not be blocked or covered. The openings should never be blocked by placing the product on a bed, sofa, rug, or other similar surface. **KEEP CURTAINS AND OTHER FLAMMABLE MATERIALS OUT OF DIRECT CONTACT WITH THE AC ADAPTOR.**
- 10. Power Sources**—This product should be operated only from the type of power source indicated on the marking label of the supplied AC Adaptor. If you are not sure of the type of power supplied to your home, consult your appliance dealer or local power company.
- 11. Lightning**—For added protection for this product during a lightning storm, or when it is left unattended and unused for long periods of time, unplug the AC adaptor from the wall outlet.
- 12. Power Lines**—An outside antenna system should not be located in the vicinity of overhead power lines, other electric light or power circuits, where it can fall into such power lines or circuits. When installing an outside antenna system, extreme care should be taken to keep from touching such power lines or circuits as contact with them may be fatal.
- 13. Overloading**—Do not overload wall outlets and extension cords as this can result in a risk of fire or electric shock.
- 14. Servicing**—Do not attempt to service this product yourself as opening or removing covers may expose you to dangerous voltage or other hazards. Refer all servicing to qualified service personnel.

**15. Damage Requiring Service**—Unplug this product from the wall outlet and refer servicing to qualified service personnel under the following conditions:

- When the AC adaptor cord or plug is damaged.
  - If the AC adaptor has been exposed to rain or water.
  - If the product does not operate normally by following the operating instructions. Adjust only those controls that are covered by the operating instructions. An improper adjustment may result in damage and will often require extensive work by a qualified technician to restore the product to its normal operation.
  - If the product has been dropped or the cabinet has been damaged.
  - When the product exhibits a distinct change in performance—this indicates a need for service.
- 16. Replacement Parts**—When replacement parts are required, be sure the service technician has used replacement parts specified by the manufacturer or have the same characteristics as the original parts. Unauthorized substitutes may result in fire, electric shock or other hazards.
- 17. Safety Check**—Upon completion of any service or repairs to this product, ask the service technician to perform safety checks to determine that the product is in proper operating condition.
- 18. Outdoor Antenna Grounding**—Before attempting to install this product, be sure the antenna or cable system is grounded so as to provide some protection against voltage surges and build-up static charges.
- Use No.10 AWG (5.3mm<sup>2</sup>) copper, No.8 AWG (8.4mm<sup>2</sup>) aluminum, No.17 AWG (1.0mm<sup>2</sup>) copper-clad steel or bronze wire or larger, as ground wire.
  - Secure antenna lead-in and ground wires to house with stand-off insulators spaced from 4 feet (1.22m) to 6 feet (1.83m) apart.
  - Mount antenna discharge unit as close as possible to where lead-in enters house.
  - A driven rod may be used as the grounding electrode where other types of electrode systems do not exist. Refer to the National Electrical Code, ANSI/NFPA 70-1990 for information.
  - Use jumper wire not smaller than No.6 AWG (13.3mm<sup>2</sup>) copper or equivalent, when a separate antenna grounding electrode is used.

EXAMPLE OF ANTENNA GROUNDING

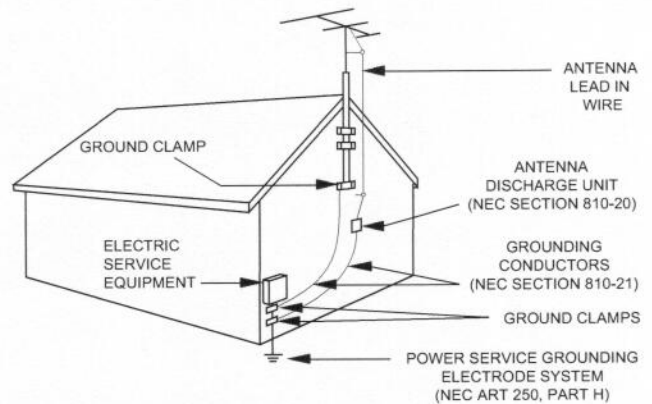

This page left intentionally blank



Thank you for purchasing an SW2 Shortwave Receiver. This receiver has been designed and manufactured to high quality standards, and will provide reliable operation for many years.

Please carefully read the Owner's Manual in order to take advantage of the many interesting features that will provide enjoyable listening to radio broadcasts around the world.

**TABLE OF CONTENTS**

<b>Important Safeguards</b>	<b>i</b>
<b>Table of Contents</b>	<b>iii</b>
<b>Specifications / Accessories</b>	<b>iv</b>
<b>Introduction</b>	<b>1</b>
<b>Front Panel Description</b>	<b>2</b>
<b>Front Panel Display Description / Rear Panel Description</b>	<b>3</b>
<b>Installation</b>	<b>4</b>
Unpacking	4
Location	4
Fixed Installation	4
Antenna Requirements	4
Operation From 12 VDC Vehicle Supply	4
Basic Antenna Connection	4
Random Length Wire Antenna Installation	5
Terms to Know	5
<b>Getting Started</b>	<b>6</b>
General Operating Information	6
Direct Frequency Entry	6
Tuning Buttons and Tuning Wheel	7
Shortwave Meter Band Designator Entry	7
AM Synchronous Operation	7
SSB Operation	8
Using the RF Gain Control	8
<b>Memory Functions</b>	<b>9</b>
Memory Channel Recalling	9
To Erase Memory Channels	9
Memory Channel Programming	9
Helpful Tips For Memory Channel Operation	9
<b>Troubleshooting</b>	<b>10</b>
<b>Service Information / If You Need To Call For Help</b>	<b>11</b>
<b>Warranty</b>	<b>13</b>

## iv Specifications / Optional Accessories

Frequency Range:	100 - 30,000 kHz	Headphone Jack:	1/8 inch stereo/mono type (monaural reception only)
Sensitivity: AM (10 dB S+N/N) (1000 Hz, 30% Mod)	Less than 2.0 $\mu$ V, typical 100 - 30,000 kHz	External Speaker:	1/4" mono type
Sensitivity: SSB (10 dB S+N/N)	Less than 0.5 $\mu$ v, 100 - 30,000 kHz	Supplied AC Adaptor Wall Transformer:	Input: 120 VAC $\pm$ 10%, 60 Hz, 15 Watts Output: 12 VAC at 1.67 A maximum
Readout Accuracy:	To nearest 0.1 kHz	DC Power Requirements:	12 VDC nominal at 1.5 A
Selectivity: AM	6 kHz @ -6 dB, less than 12 kHz @ -60 dB	Operating Temperature:	0° to +50° C
Selectivity: SSB	2.3 kHz @ -6 dB, less than 5 kHz @ -60 dB	Weight:	5.8 lbs. 2.6 Kg, (includes AC Adaptor)
IF Frequency:		Size:	Width: 10-7/8" (27.6 cm) Height: 4-3/8" (11.1 cm) (includes feet) Depth: 7-5/8" (19.4 cm), (including front knobs and rear panel connector)
1st IF:	55.845 MHz		
2nd IF:	455 kHz		
Step Sizes:	50 Hz with Tuning Wheel 5 kHz with  /  buttons		
Antenna Inputs:	SO-239 connector, 50 Ohms Screw terminal, 50 Ohms		

### OPTIONAL ACCESSORIES:

#### 1) Plastic Carrying Handle for the SW2

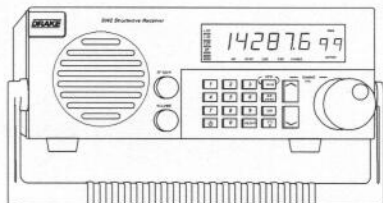

#### 2) MMK-1 Mobile Mounting Kit:

A- Inverted Mounting (under a dash or overhead surface, etc.)

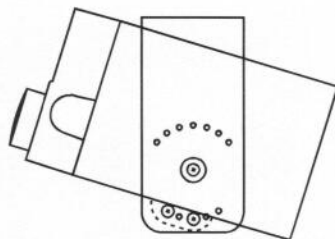

B- Upright Mounting (for dash top or floor, etc.)

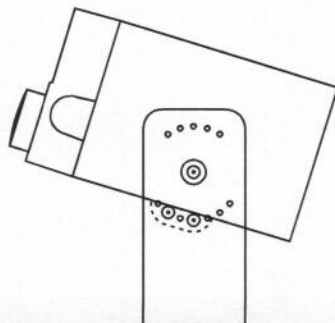

#### 3) Infrared Remote Control:

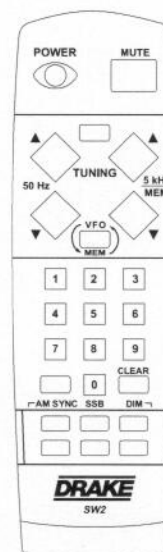

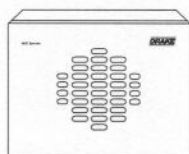

#### 4) MS8 External Speaker

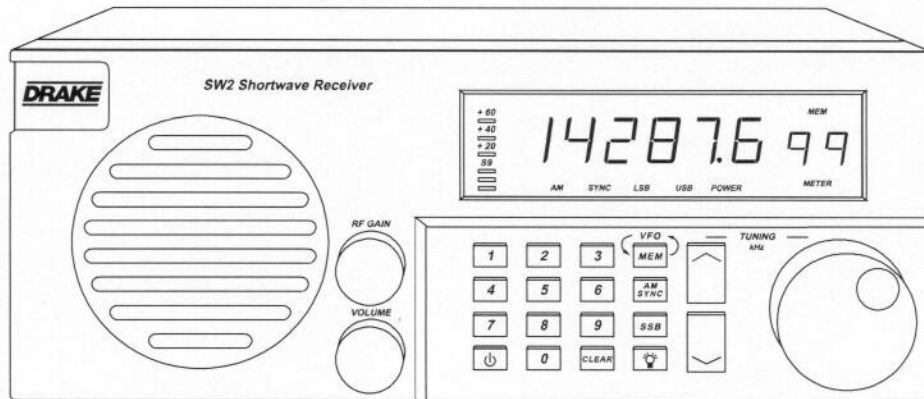

Downloaded by   
Amateur Radio Directory   
  
[www.hamdirectory.info](http://www.hamdirectory.info)



The SW2 is a microprocessor controlled, synthesized, shortwave receiver with continuous coverage capability from 100 kHz through 30000 kHz which includes the AM broadcast, Amateur, CB and shortwave bands. The SW2 offers good sensitivity, selectivity, dynamic range and features that permit easy tuning of desired stations. Conveniently located front panel controls allow for rapid tuning to a particular frequency. The SW2 is easy to use. The operating frequency can be tuned via a tuning wheel,  /  tuning buttons, or by direct numeric entry.

Reception modes include Lower Sideband (LSB), Upper Sideband (USB), AM in the Shortwave and AM broadcast band. For the Shortwave and AM broadcast bands, a selectable sideband synchronous detector (SYNC) allows for enhanced reception by eliminating or reducing distortion due to fading signals.

The RF Gain is adjustable via a front panel control. Dual antenna input terminals on the rear panel provide versatile and practical connection of either a coaxial 50 Ohm feedline or wire antenna connection to the receiver. A front panel LED display shows the receive frequency. Relative Signal strength is indicated by an LED bar graph. Mode of operation and connection to a source of AC (or DC) power are indicated by additional LEDs. The receiver can be operated from the supplied AC Adaptor which provides 12 VAC power, or from a nominal 12 VDC power source.

The receiver allows for 100 independent, programmable memories. These memories do not require battery backup and are thus unaffected by power interruptions. All parameters associated with a particular memory channel are stored including the frequency, mode, and detector mode. A few popular channels have been preprogrammed. Any memory channel can be programmed as desired.

## 2 Front Panel Description

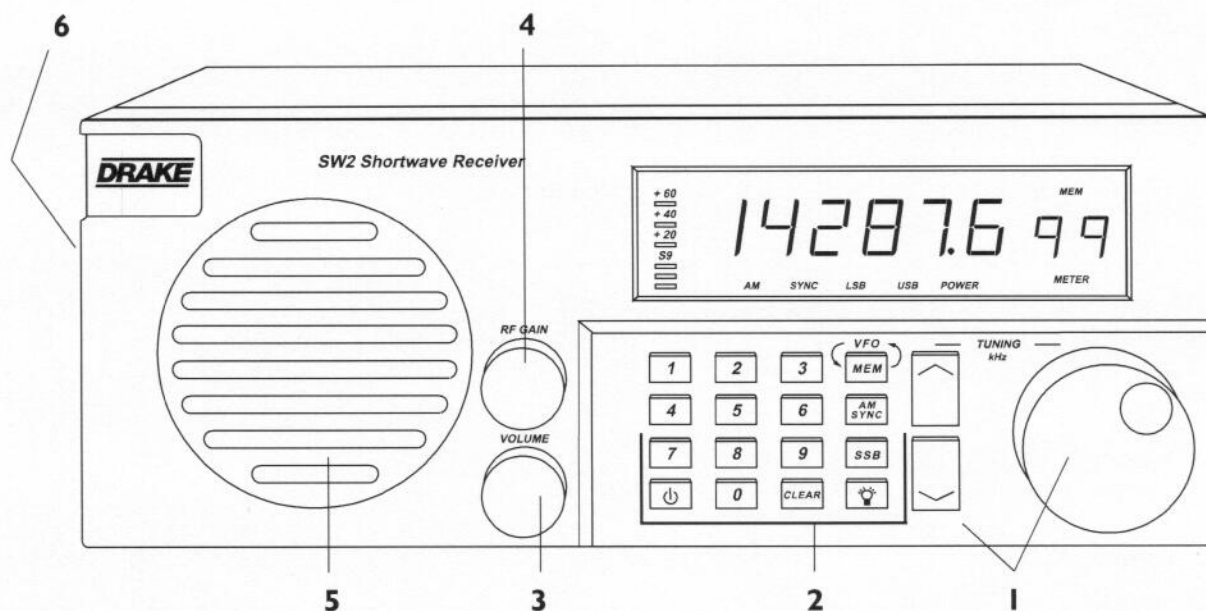

**1) Tuning (VFO)\***- The tuning wheel and the / buttons are the primary tuning controls of the receiver. Clockwise rotation of the dial increases frequency in 50 Hz steps and counterclockwise rotation decreases frequency in 50 Hz steps. The / buttons increment and decrement the frequency in 5 kHz steps. Press and hold the or and the rate of 5 kHz steps will increase.  
\*The VFO (Variable Frequency Oscillator) represents the normal tuning mode of the receiver.

### 2) Program Buttons

- Numeric buttons - Permit direct entry of receive frequency in kHz from 100 to 30000 kHz.

- Press to cancel an entered frequency and restore the previously displayed frequency or to exit the memory mode.

- Press to turn the receiver On or Off. The frequency readout will be displayed when the receiver is turned on.

- Press to toggle the display brightness between normal and dimmer settings.

- Press to enter Memory Recall mode ('MEM' LED will light). Press and hold for approximately 2 seconds to enter the Memory Store mode ('MEM' LED will flash).

- **AM SYNC** - Press to select the AM mode of operation. The AM indicator lights. Successive depressions toggles the synchronous detector on (AM and SYNC indicators lit) and off. For a detailed operation description, see 'AM SYNCHRONOUS OPERATION' in the 'GETTING STARTED' section of this manual.

- **SSB** - Press to select the SSB mode of operation ('AM SYNC' must be turned off). Successive depressions select alternately the 'LSB' or 'USB' modes as displayed by the corresponding indicator. For a detailed operation description, see 'SSB OPERATION' in the 'GETTING STARTED' section of this manual.

**3) VOLUME** - Turn this control clockwise to increase the volume setting. Turn this control counterclockwise to reduce the volume setting.

**4) RF GAIN** - This control adjusts the RF gain of the receiver and is normally set for the fully clockwise position. Turn the control counterclockwise, as required, to reduce the receiver gain for reception of strong signals.

**5) SPEAKER** - This is the opening for the internal speaker of the receiver.

**6) HEADPHONE JACK** - This connector accepts a 1/8" stereo/mono headphone connector. Reception is monaural only.



## Front Panel Display Description

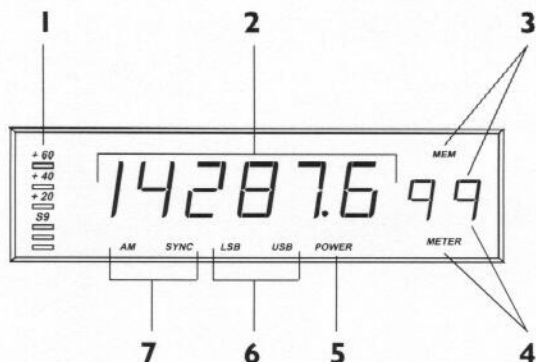

**1) Bar Graph** - This bar graph display indicates the relative received signal level in S-units and dB above S9.

**2) 6 Digit Readout** - This display indicates the operating frequency of the receiver. The frequency is displayed in 'kHz'.

**3) <sup>MEM</sup> 99** - This annunciator indicates current memory location from 00 to 99. MEM will light when the receiver enters the memory mode. Refer to the 'MEMORY FUNCTIONS' section of this manual.

**4) <sup>METER</sup> 99** - Lights in the VFO mode to indicate the Shortwave band designators that define a range of frequencies for each band. Refer to the "Shortwave 'Meter' Band Designator Entry" section of this manual.

**5) POWER** - Indicates that the AC Adaptor is connected and plugged into an AC wall outlet.

**6) LSB / USB** - LSB Indicates that the Lower sideband mode of detection is on. USB indicates that the Upper sideband mode of detection is on.

**7) AM / SYNC** - Indicates that the AM mode of reception is on. If SYNC is also illuminated, then the synchronous AM mode of detection is on. With SYNC active, select USB or LSB for best reception.

## Rear Panel Description

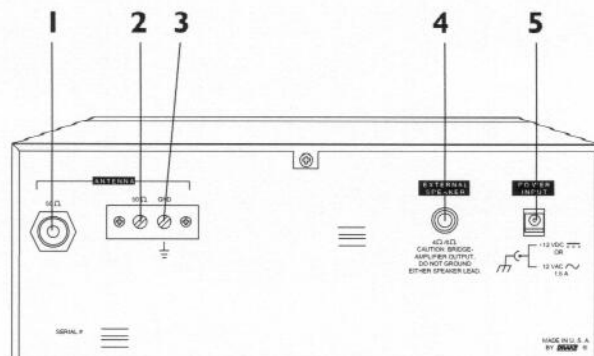

**1) 50 Ohm SO-239 Connector** - This antenna input is a 50 Ohm, SO-239 coaxial input requiring a mating PL-259 connector. This input would typically be used as the primary antenna input. Antennas such as dipoles, trap dipoles, verticals and beams will provide the best results depending upon the desired receiving frequency.

**2) 50 Ohm Antenna Wire Screw Terminal** - This antenna input is a 50 Ohm screw terminal type requiring bare wire from an antenna to be compressed under the screw heads. An antenna such as a random-length wire will provide the best results.

**3) GND (ground) Connection** - This is the point from which the receiver may be grounded in order to improve reception when using, for example, a random length antenna.

**4) EXTERNAL SPEAKER** - This connector accepts a 1/4" stereo/mono audio jack. Reception is monaural only. Do not ground either speaker lead.

**5) POWER INPUT** - This is for the AC adaptor.

## 4 Installation

**UNPACKING** - Carefully remove the SW2 and included AC Adaptor wall transformer from the shipping carton and examine them for evidence of damage. If any damage is noted, immediately contact the transportation company responsible for delivery or return the unit to the dealer from whom it was purchased. Keep the shipping carton and all packing material for the transportation company to inspect. The original carton and packing material should be retained for repackaging should it be necessary to return the receiver. Inspect the packing material for any accessories or printed material before storing the box.

**LOCATION** - Location is not critical. For fixed locations, the SW2 should be operated from the AC Adaptor. Keep curtains and other flammable material away from direct contact with the AC Adaptor to avoid overheating the transformer which could result in failure or fire.

**FIXED INSTALLATION** - After unpacking the unit, connect the antenna system to the appropriate antenna input. Connect system ground to the screw terminal marked 'GND'. Plug the output cable of the AC Adaptor into the 'POWER INPUT' connector on the rear panel of the receiver. Plug the AC Adaptor into a source of 120 VAC, 60 Hz power. Refer to Figure 2 for the diagram of a typical fixed installation.

### ANTENNA REQUIREMENTS - Basic type

Connect a single wire lead-in to the '50 Ohm' screw terminal on the rear panel of the receiver. This "lead-in" wire and antenna can simply be one end of the supplied 30 feet piece of wire. The wire can be distributed along an attic, out the window, or across the room, for example. The end that connects to the '50 Ohm' screw terminal must have its insulation stripped back so that a good electrical connection is made between the wire and the screw terminal.

Alternatively, a 50 Ohm coaxial cable feedline from a dipole, vertical or beam type antenna should be connected to the rear panel '50 Ohm' SO-239 coaxial type antenna connector. A mating PL-259 connector on the receiver end of the coaxial cable is required, in this case.

**NOTE:** Disconnect the AC Adaptor and antenna wire from the receiver if the unit will not be used for an extended period of time or if a storm containing damaging lightning is likely.

### OPERATION FROM 12 VDC VEHICLE SUPPLY -

Observe proper polarity connection between the vehicle lighter or accessory socket and the coaxial DC power plug (5.5 mm O.D., 2.1 mm I.D.) which is intended for connection to the SW2 power socket. The exposed outside metal shell of the 5.5 mm power plug is the "-" (Negative) connection to the SW2 rear panel connector socket. The inside metal contact surface is the "+" (Positive) connection to the SW2 rear panel connector socket.

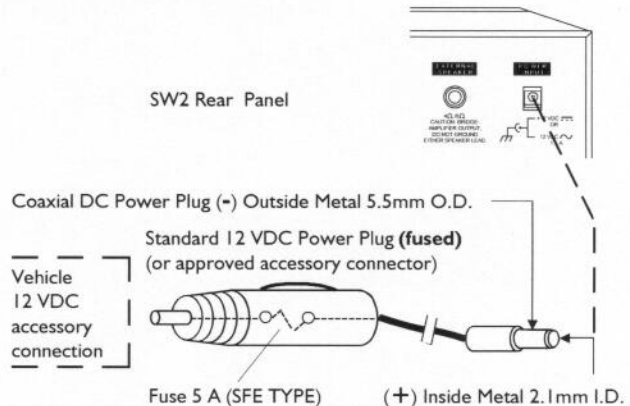

**FIGURE 1 - PROPER WIRING POLARITY AND FUSING DIAGRAM**

**WARNING:** Stay away from power lines when you install this, or any, antenna. Make certain that the antenna cannot come in contact with power lines.

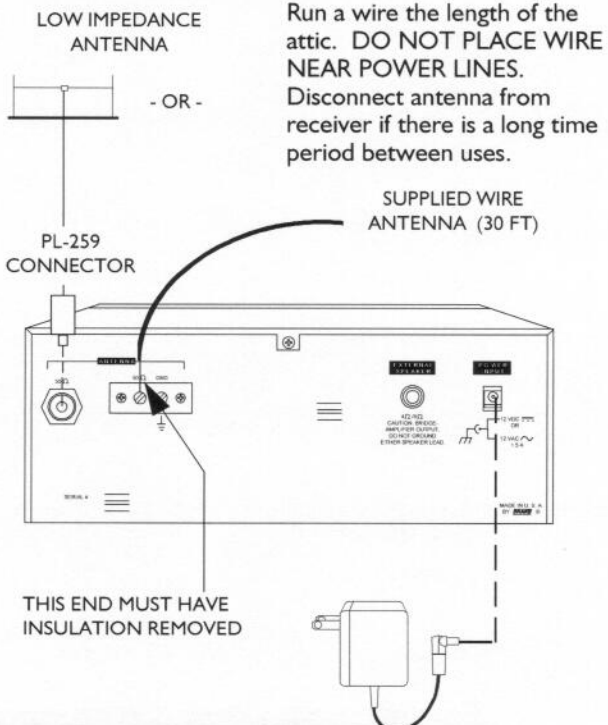

**FIGURE 2 - BASIC ANTENNA CONNECTIONS**

**RANDOM LENGTH WIRE ANTENNA INSTALLATION**

For general broadcast and shortwave listening, an outside random-length wire antenna can be used. Figure 3 shows a typical random-length wire antenna installation. The length of the wire may be from 30 to 100 feet. Attach and solder the lead-in to one end of the antenna. Connect the other end of the lead-in wire to the '50Ω' screw terminal on the rear panel of your receiver.

Generally, the higher the antenna is off the ground, the better the reception. You may use a tree or a pole as one support and your house as the other support. Use insulators at each end of the antenna to separate the antenna wire from the support wire. It is recommended to install a lightning arrester on the lead-in wiring, especially if the antenna is outdoors and of lengths exceeding approximately 30 feet.

**\* A Note About Grounding:**

A ground wire is not necessary for proper reception with this receiver when using the supplied 30 feet piece of wire or when using resonant length type antennas (dipole, vertical, or beam antennas). A ground wire may improve reception, however, in some cases, when using random length antennas.

**TERMS TO KNOW**

*Antenna* - A length of bare antenna wire.

*Lead-in* - A length of insulated wire. The length depends upon the height of your antenna and the location of your receiver.

*Ground Wire* - If used, connect a heavy wire from the 'GND' screw terminal on the rear panel of your receiver to a cold water pipe or to a 6- to 8-foot long piece of ground rod driven into the earth. The length of your ground wire depends upon the distance between your receiver and the grounding surface. (See "A Note About Grounding" on this page.)

*Insulators* - A ceramic or glass type, approximately 2-1/2 inches long.

*Ground rod* - A 6-foot to 8-foot length, 3/8-inch diameter conductive rod. NOTE: A ground rod is not needed if you use an alternate ground, such as the cold water pipe in your house.

*Clamp* - A device used to connect a ground wire to a ground rod.

*Lightning arrester* - A device used to discharge lightning to the ground, protecting electronic equipment.

For additional information on antennas, contact your local library.

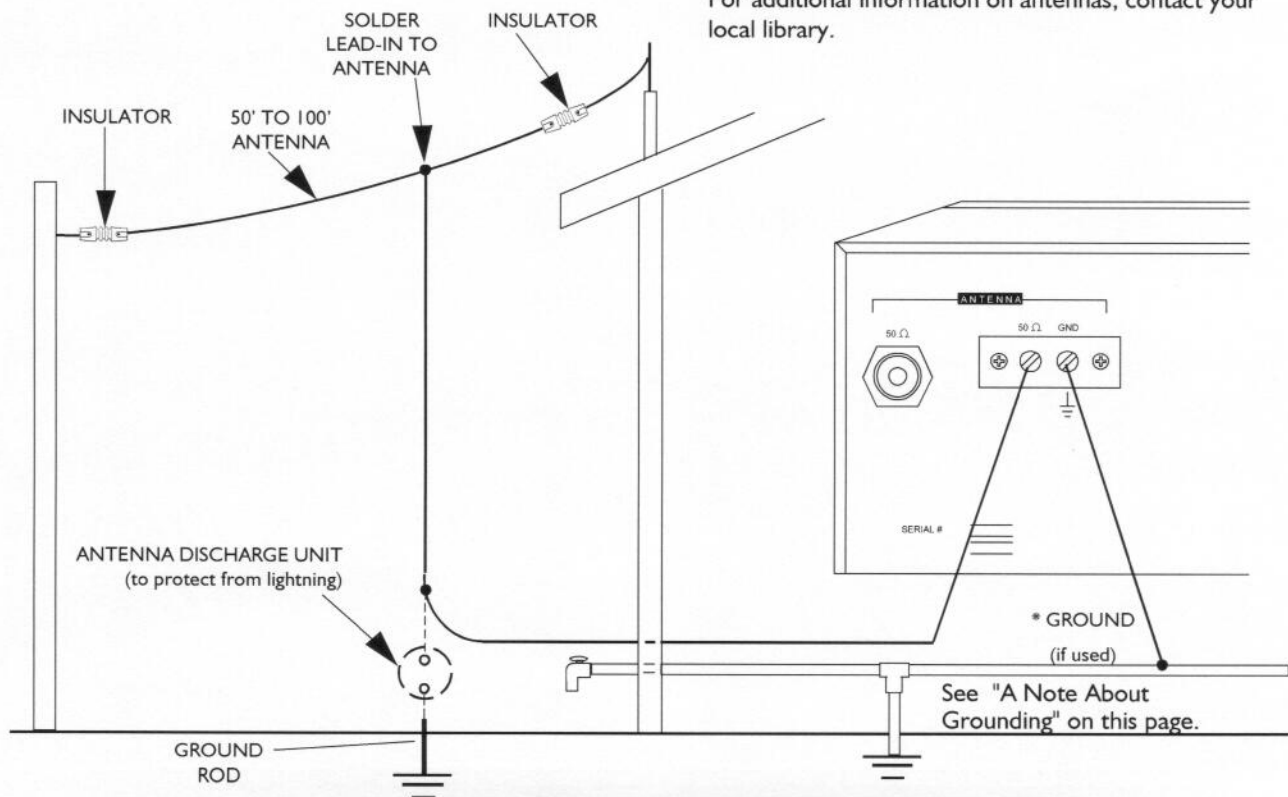

**FIGURE 3 - RANDOM LENGTH WIRE ANTENNA**

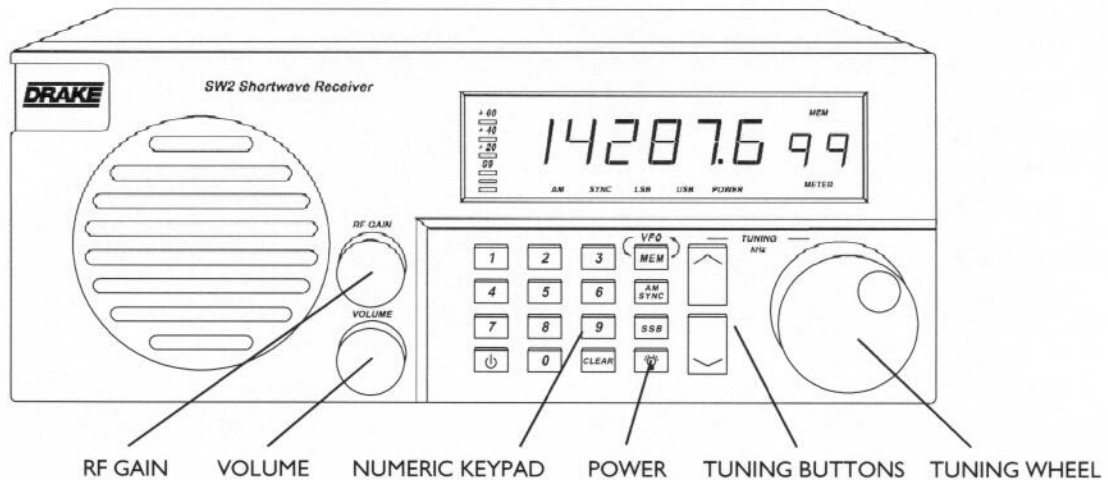

**FIGURE 4**

### GENERAL OPERATING INFORMATION

This receiver is easy to use. Please take a few moments to read through this section and familiarize yourself with general operating information.

### GETTING STARTED

1. Connect the AC Adaptor to the receiver and plug the AC Adaptor into a source of nominal 120 VAC, 60 Hz power. POWER LED SHOULD LIGHT UP.
2. Make certain that an antenna connection is made to the appropriate rear panel 'ANTENNA' connector or screw terminal.
3. Please refer to Figure 4. Press the  button to turn on the SW2. The display will show the receive frequency. Set the RF GAIN control fully clockwise. Set the VOLUME control for a comfortable volume level.
4. Please refer to Figure 4. Tune to the desired frequency by using one of several methods covered below.

This communications receiver is calibrated in Kilohertz (kHz) and, accepts frequency entries only in 'kHz'. It will help to become familiar with these terms:

**Kilohertz:** Kilo means thousand. A Kilohertz is 1000 Hertz or 1000 cycles-per-second and is abbreviated 'kHz'.

**Megahertz:** Mega means million. A Megahertz is 1,000,000 Hertz or 1,000,000 cycles-per-second and is abbreviated 'MHz'.

Thus the relationship of these two frequency quantities is:  
1 MHz = 1,000 kHz

Examples: 5.875 MHz = 5875 kHz

29.660 MHz = 29660 kHz

**Meter:** The term meter, as applied to shortwave listening, refers to the wavelength of a radio frequency. In many parts of the world, frequencies are listed in meters, for example, international shortwave stations in the 19 Meter band.

European radio equipment and stations often refer to the wavelength of a station or band (in meters), rather than frequency (in MHz or kHz). To convert MHz to meters, use this formula:

$$\text{METERS} = 300/\text{Frequency (MHz)}$$



Example: What is the wavelength of 6120 kHz (6.120 MHz)?

$$300/6.120 \text{ MHz} = 49 \text{ Meters}$$

### DIRECT FREQUENCY ENTRY

Enter the desired frequency by pressing the numeric buttons. Frequency is entered in kilohertz (kHz). Entries from 100 kHz to 30000 kHz are valid.

**NOTE:** The receiver will prompt with 'Error' if an invalid frequency is attempted.





Direct entry of a desired frequency is possible using the keys 0-9 and the  or  buttons. If an incorrect frequency has been entered, press the clear button to erase the entry and return the receiver to its previous settings.

Enter a frequency as follows:

1) Entry is in kHz (kilohertz). A maximum of 5 digits may be entered.

Example 1: 700 kHz

Press , , , then  or .

\* The depression of the  or  buttons acts as an enter button and causes immediate response to the entered frequency. If the  or  buttons are not pressed at the end, the receiver will automatically enter the desired frequency after a slight delay.

Example 2: 29660 kHz \*\*

Press , , , ,

\*\* When the maximum of 5 digits are entered, the receiver will automatically enter the frequency as soon as the last digit is pressed.

### TUNING BUTTONS and TUNING WHEEL

Tuning to a desired frequency can also be accomplished by pressing the  /  Tuning buttons and/or turning the Tuning wheel. The frequency will change in 5 kHz increments with the  /  Tuning buttons, and will change in 50 Hz increments when turning the Tuning wheel.

Pressing and holding the  /  buttons will cause the tuning rate to increase after a short period of time.

### SHORTWAVE 'METER' BAND DESIGNATOR ENTRY

To facilitate tuning to particular sections of the shortwave band that contain many worldwide broadcasts of news, information and music, the SW2 displays the 'METER' band if the receiver is tuned to a frequency that is contained by designated shortwave bands. If the receiver enters one of the 'METER BANDS', the number of that band will be displayed on the right side of the display, above the 'METER' LED. In some cases, the worldwide broadcast station may not announce its exact operating frequency, but will announce the 'METER' band in which it is operating or to which band it will move to improve worldwide reception at a particular time of day. The Shortwave Band Designators and corresponding frequency ranges are as follows:

#### Shortwave Band Designators

120 METER:	2300 - 2500 kHz	('120' is not displayed)
90 METER:	3200 - 3400 kHz	
75 METER:	3900 - 4000 kHz	
60 METER:	4750 - 5060 kHz	
49 METER:	5800 - 6200 kHz	
41 METER:	7100 - 7600 kHz	
31 METER:	9500 - 9900 kHz	
25 METER:	11600 - 12100 kHz	
22 METER:	13570 - 13870 kHz	
19 METER:	15100 - 15800 kHz	
16 METER:	17480 - 17900 kHz	
13 METER:	21450 - 21850 kHz	
11 METER:	25600 - 26100 kHz	

Other bands used by Amateur radio operators (HAMS) are displayed when in SSB mode of operation. The Amateur Band Designators and corresponding frequency ranges are as follows.

#### Amateur Band Designators

80 METER:	3500 - 4000 kHz
40 METER:	7000 - 7300 kHz
30 METER:	10,100 - 10,150 kHz
20 METER:	14,000 - 14,350 kHz
17 METER:	18,068 - 18,168 kHz
15 METER:	21,000 - 21,450 kHz
12 METER:	24,890 - 24,990 kHz
10 METER:	28,000 - 29,700 kHz

### AM SYNCHRONOUS OPERATION

For general tuning and listening, normal AM is best. If, however, the received signal sounds distorted, or interference from adjacent stations is present, AM synchronous should be engaged. The synchronous detector in your receiver can greatly reduce the severe audio distortion that can occur due to selective signal fading. The synchronous detector also permits selectable tuning to either the upper or lower sideband portion of an AM signal. Since most all AM (LW, MW and SW) broadcasting generally uses double-sideband transmission, synchronous detection of either of the two sidebands results in full reception of the transmitted information. The selectable sideband tuning and synchronous detection not only aids reception by permitting tuning to the stronger or less distorted sideband, but also permits rejection of the sideband nearer to the interfering signal(s). For Example:

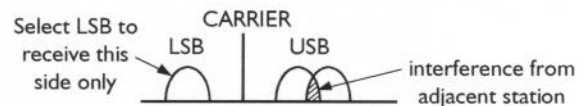

The synchronous detector will lock to the strongest signal that is within the IF passband when it is activated. Most of the time, the strongest signal will be the carrier of the desired signal. First, be sure the main tuning is set to within 1 kHz of the desired station's transmitting frequency. Press the  button to activate synchronous operation. If adjacent channel interference or any other undesired signal is sufficiently strong, the synchronous detector may lock to it instead. In that case, press the  button to turn the synchronous detector off and repeat the tuning process.

### **AM SYNCHRONOUS OPERATION, continued**

If interference is present, press the **SSB** button to select the sideband with the least interference. When AM/SYNC has been activated, moving the main tuning knob will cause the SYNC circuit to momentarily disengage (indicated by 'SYNC' flashing), then back on again when tuning has stopped. AM SYNC will not operate properly on intermittent transmissions such as those encountered on CB radio bands, for example. For those types of transmissions, use the AM mode.

**Press the **AM SYNC** button to turn the synchronous detector off (return to the AM mode) before selecting LSB or USB modes.**

### **SSB OPERATION**

Activate SSB mode by pressing the **SSB** button. AM SYNC must be turned off.

Tuning in a single sideband (SSB) signal can be somewhat frustrating for the first time listener. In either of the SSB modes, LSB (lower sideband), or USB (upper sideband), the receiver will select the 2.3 kHz bandwidth automatically. Generally, LSB is used below 10 MHz and USB is used above 10 MHz. When initially tuning in the desired station, tune slowly. If the station is unintelligible, try the other sideband, again tuning slowly. A station tuned in on the wrong sideband is totally unreadable but a station mistuned on the correct sideband may sound like 'Donald Duck'. Further tuning will result in a more normal voice pitch.

### **USING THE RF GAIN CONTROL**

Maximum receiver sensitivity is obtained with the RF GAIN control set fully clockwise. Rotating the control counterclockwise reduces the receiver gain, thereby allowing reception of only relatively strong signals. For most normal operation, the control is set fully clockwise. If signal distortion is noticed, which is possible when tuning in very strong (local) stations, rotate the control counterclockwise until the distortion just disappears and the desired station is still heard. The RF GAIN control can also be rotated counterclockwise to reduce background noise when no signal is present (during tuning, for example), but only relatively strong signals will be heard with a reduced RF GAIN control setting.



This receiver contains 100 memories (00-99) that can be used to store and recall commonly monitored frequencies. The following operating parameters are also stored with any memory channel:

1) Frequency 2) Mode 3) Synchronous Detector

NOTE: Some of the 100 memory channels are factory programmed to help the user get started.

### MEMORY CHANNEL RECALLING

To recall any of the 100 memory channels of the SW2,



simply press the  button, the MEM LED will light and the receiver will tune to the last used memory channel or default to channel '00'. A channel number can be accessed directly, by entering the desired two digit channel number. A channel number can also be accessed by scrolling through the channels with either the tuning wheel and or the  /  buttons. While scrolling through the channels the receiver continues to tune to that frequency and the mode settings for that channel.

NOTE: While scrolling through memory channels, if a channel is empty, it will be skipped numerically.

If it is desired to return the receiver to the frequency

tuned in the VFO mode, simply press the  button and the receiver returns to VFO mode and MEMORY RECALL mode is exited. However, if it is desired to load that memory channel into the VFO,

press and hold the  button. The channel will be loaded and MEMORY RECALL mode will be exited. At this point, the receiver can once again be tuned. The

 button or the  button can be used to exit MEMORY RECALL mode if that mode is entered accidentally or it is desired to exit MEMORY RECALL.



The  button is also used to erase mistakes made during direct entry of a memory channel.



**To Erase Memory Channels** - While in MEMORY RECALL mode, simply pick a memory channel to erase. Press and hold the  button until the channel is removed from the display. The receiver will change to the next ascending available memory channel.



### MEMORY CHANNEL PROGRAMMING

First, be certain that the receiver is in VFO mode (MEM is not lit). Then tune the receiver to the frequency to be stored as a memory channel. Press and hold the

 button for at least two seconds or until MEM

lights and the memory channel showing "--" is flashing. The receiver is now in the MEMORY STORE mode. If it is known into which memory channel number the desired frequency is to be stored, simply enter the two digit location. Upon entry of the second digit, the SW2 will flash what is currently stored in that memory channel (if it is not desired to store the channel at this time, press the  button and the SW2 will return to the original MEMORY STORE mode display). To store the chosen channel, press the  button and the SW2 will "scroll" the desired frequency into the display and store the frequency and all of the current mode settings.

If unsure of where to store a frequency, (while in MEMORY STORE mode), simply scroll through all of the memory channels and their current contents by using the tuning wheel and or the  /  buttons. All information will flash in the display while scrolling. NOTE: Empty memory channels are displayed as blanks in the frequency display section with only the memory channel number flashing. Once a suitable channel

location is found, simply press the  button and the frequency is "scrolled" into the display and all information is stored. NOTE: While scrolling through all the memory channels and looking for a suitable location, the SW2 is **NOT** tuning to the stored contents of the memory channels, and the audio of the desired frequency remains unchanged. The  button is used to exit MEMORY STORE mode if it is accidentally entered or upon exiting the mode. The  button is also used to erase errors made during direct entry of a memory channel.

### HELPFUL TIPS FOR MEMORY CHANNEL OPERATION

The following helpful tips for memory channel operation may be useful to the novice shortwave listener.

- 1) Put all of the favorite stations in the first 20 memory channels (00-19).
- 2) Place all AM broadcast stations together in a designated section of memory channels, while placing shortwave stations in another section.
- 3) Place shortwave or amateur frequencies into a location that corresponds with their meter designator. For example, shortwave stations found in the 75 meter band (3900-4000kHz) could be placed into memory locations 70-79.
- 4) Place all meter band designator locations with leading frequencies in memory channels corresponding to their meter band designators. For example, use memory channel 19 to store 15100 kHz. This will allow quick access to the beginning of the 19 meter band.

# 10 Troubleshooting

## TROUBLESHOOTING

<b>PROBLEM</b>	<b>PROBABLE CAUSE</b>	<b>SOLUTION</b>
<b>No front panel display</b>	<p>A) No power applied either by AC Adaptor or DC source.</p> <p>B) Defective AC Adaptor or blown fuse in DC power cable (if DC is the intended source).</p> <p>C) Receiver in the power OFF mode.</p>	<p>A) Check that AC Adaptor cable or DC cable is properly connected to the rear panel POWER INPUT connector. Check that the AC Adaptor is plugged into a source of nominal 120 VAC power source.</p> <p>B) Check the AC Adaptor and replace if defective. Check DC power source, fuse and cable.</p> <p>C) Press the  button for a frequency display.</p>
<b>Stations sound is distorted</b>	<p>A) Receiver is not tuned onto the station properly.</p> <p>B) RF GAIN control set fully clockwise and receiving a very powerful, nearby radio station.</p>	<p>A) Slowly turn the tuning wheel to clarify the sound.</p> <p>B) Rotate the RF GAIN control counterclockwise until the distortion just disappears or is reduced. Adjust to full gain when retuning to a weaker station.</p>
<b>Weak stations are hard to receive</b>	<p>A) RF GAIN control not set fully clockwise.</p> <p>B) Ineffective length and placement of antenna.</p>	<p>A) Adjust RF GAIN control clockwise until weaker stations are received</p> <p>B) Make sure the antenna is properly connected and of effective length. Check for proper placement (height above ground, etc.).</p>

Downloaded by   
Amateur Radio Directory   
  
[www.hamdirectory.info](http://www.hamdirectory.info)



## SERVICE INFORMATION

You may contact R. L. DRAKE Service Department for additional information or assistance by calling (513) 746-6990, Monday through Friday, 8:00 A.M. - 5:00 P.M. EST, except on holidays.

You may also contact the R. L. DRAKE Service Department by E-mail at the following address: [service@rldrake.com](mailto:service@rldrake.com)  
or by Telefax:  
+1 (513) 743-4576.

Should you want to return your unit for service, package the receiver carefully using the original carton or other suitable container.

Write your return address clearly on the shipping carton and on an enclosed cover letter describing the service required, symptoms or problems. Also include your daytime telephone number and a copy of your proof of purchase.

The receiver will be serviced under the terms of the R. L. Drake Company Limited Warranty and returned to you.

## IF YOU NEED TO CALL FOR HELP

Call our Customer Service/Technical Support line at (513) 746-6990 between 8:00 a.m. and 5:00 p.m. EST, weekdays. Please have the unit's serial number available. We will also need to know the specifics of any other equipment connected to the unit. When calling, please have the unit up and running, near the phone if possible. Our technician(s) will likely ask certain questions to aid in diagnosis of the problem. Also, have a voltmeter handy, if possible.

R. L. DRAKE also provides technical assistance by e-mail: [bill\\_frost@rldrake.com](mailto:bill_frost@rldrake.com)  
or by Telefax: +1 (513) 743-4576.

Many of the products that are sent to us for repair are in perfect working order when we receive them. For these units, there is a standard checkout fee that you will be charged. Please perform whatever steps are applicable from the installation sections of the Owner's Manual before calling or writing—this could save unnecessary phone charges. Please **do not** return the unit without contacting R. L. Drake first: it is preferred to help troubleshoot the problem over the phone (or by mail) first, saving you both time and money.

Inside the carton, enclose a note with your name, address, daytime phone number, and a description of the unit's problem.

The unit must be sent to the following address:  
R. L. Drake Company  
230 Industrial Drive  
Franklin, Ohio 45005 U.S.A.

Be sure to include your street address which will be needed for UPS return. UPS Surface (Brown Label) takes 7-10 days to reach us depending on your location, Blue takes 2-3 days. Red is an overnight service

and is expensive. Send the unit in a way that it can be traced if we can't verify receipt of shipment. We suggest UPS or insured postal shipment.

If the unit is still under the original owner's warranty, R. L. DRAKE will pay the cost of the return shipment to you. Our return shipping policy is that we will return it UPS Brown if received Brown or by US Mail, it will be returned Blue if received Blue or Red—or it will be returned however you prefer if you furnish the return cost for the method you select.

If the unit is out of warranty, it will be returned by UPS Brown label COD unless:

- 1) It was received UPS Blue/Red, in which case it will be returned UPS Blue/Red COD;
- 2) You designate billing to American Express, VISA, MasterCard or Discover card;
- 3) You prepay the service charges with a personal check, or
- 4) You specify some other method of return.

When calling, the technician can estimate the repair charges for you over the phone. This is another good reason to call before sending a unit in for repair. Typically, equipment is repaired in five to ten working days after it arrives at R. L. DRAKE *if we have all the facts*. If we must call you, it may take longer. R. L. DRAKE is not responsible for damage caused by lightning, nonprofessional alterations, "acts of God", shipping damage, poor storage/handling, etc. R. L. Drake will make note of any shipping damage upon receipt.

Should your warranty card not be on file at R. L. DRAKE, you will need to send proof of purchase to receive warranty service. Typically, a copy of the invoice from an R. L. DRAKE dealer will suffice. The warranty is for the original owner only and is not transferable.

This page left intentionally blank

## One Year Limited Warranty

R.L.DRAKE COMPANY warrants to the original purchaser this product shall be free from defects in material or workmanship for one (1) year from the date of original purchase.

During the warranty period the R.L.DRAKE COMPANY or an authorized Drake service facility will provide, free of charge, both parts and labor necessary to correct defects in material and workmanship. At its option, R. L. Drake Company may replace a defective unit.

To obtain such warranty service, the original purchaser must:

- (1) Complete and send in the Warranty Registration Card within 10 days of purchase.
- (2) Notify the R.L.DRAKE COMPANY or the nearest authorized service facility, as soon as possible after discovery of a possible defect, of:
  - (a) the model and serial number,
  - (b) the identity of the seller and the approximate date of purchase; and
  - (c) A detailed description of the problem, including details on the electrical connection to associated equipment and the list of such equipment.
- (3) Deliver the product to the R.L.DRAKE COMPANY or the nearest authorized service facility, or ship the same in its original container or equivalent, fully insured and shipping charges prepaid.

Correct maintenance, repair, and use are important to obtain proper performance from this product. Therefore carefully read the Instruction Manual. This warranty does not apply to any defect that R.L.DRAKE COMPANY determines is due to:

- (1) Improper maintenance or repair, including the installation of parts or accessories that do not conform to the quality and specifications of the original parts.
- (2) Misuse, abuse, neglect or improper installation.
- (3) Accidental or intentional damage.

All implied warranties, if any, including warranties of merchantability and fitness for a particular purpose, terminate one (1) year from the date of the original purchase.

The foregoing constitutes R.L.DRAKE COMPANY'S entire obligation with respect to this product, and the original purchaser shall have no other remedy and no claim for incidental or consequential damages, losses or expenses. Some states do not allow limitations on how long an implied warranty lasts or do not allow the exclusions or limitation of incidental or consequential damages, so the above limitation and exclusion may not apply to you.

This warranty gives you specific legal rights and you may also have other rights which vary from state to state. This warranty shall be construed under the laws of Ohio.

### For service information contact:

**R.L. DRAKE COMPANY**  
230 Industrial Drive  
Franklin, Ohio 45005

Customer Service Center Phone: +1 (513) 746-6990    TELEFAX: +1 (513) 743-4576

**DRAKE**®

R.L. DRAKE COMPANY  
230 INDUSTRIAL DRIVE  
FRANKLIN, OHIO 45005 U. S. A.  
CUSTOMER SERVICE AND PARTS TELEPHONE:  
+1 (513) 746-6990  
TELEFAX:  
+1 (513) 743-4576  
WORLD WIDE WEB SITE: <http://www.rldrake.com>

Downloaded by   
Amateur Radio Directory   
  
[www.hamdirectory.info](http://www.hamdirectory.info)